

LTPRUP series

90W strobe LED pattern projectors



KEY ADVANTAGES

Ultra high-power light output and strobe mode only operation

Low sensitivity to ambient light for the inspection of fast moving objects and an extended LED lifetime.

LED technology

Thinner lines, sharper edges and more even illumination than lasers.

Repeatable results with dedicated strobe controllers

Compatible LTDV series ensures very stable illumination intensity.

Wide selection of projection patterns available

Chrome-on-glass patterns with geometrical accuracy down to 2 µm.

Compatible with any C-mount optics.

LTPRUP series are the most powerful LED pattern projectors designed for fast image acquisition in high speed applications where camera exposure time must be set to the minimum, including planarity control of opaque products, robot guidance for fast pick and place and 3D profiling.

LTPRUP projectors are strobe only and provide ultra-high intensity while ensuring extended LED lifetime and reduced heat generation. LTPRUP series are current driven and can be precisely controlled using compatible LTDV strobe controllers series.

LTDV controllers are designed to drive the LED of LTPRUP pattern projectors with perfectly constant current, ensuring repeatable results even in applications where low exposure time is required.

This minimizes illumination intensity variations down to ± 1%, leading to accurate and repeatable results when compared to models offered by major competitors.

Additionally, rise and fall time are kept to the minimum: this ensures repeatable results specifically in applications where light intensity is controlled through time-dimming.

Multiple interchangeable patterns, either stripe or grid styles, are available along with optional custom patterns. LTPRUP is easily integrated into any system thanks to its compact design, multiple threaded holes positioned in the rear part, and compatibility with CMHO016 clamping mechanics. Additionally the phase-adjustment design allows for easy pattern alignment.

Application examples

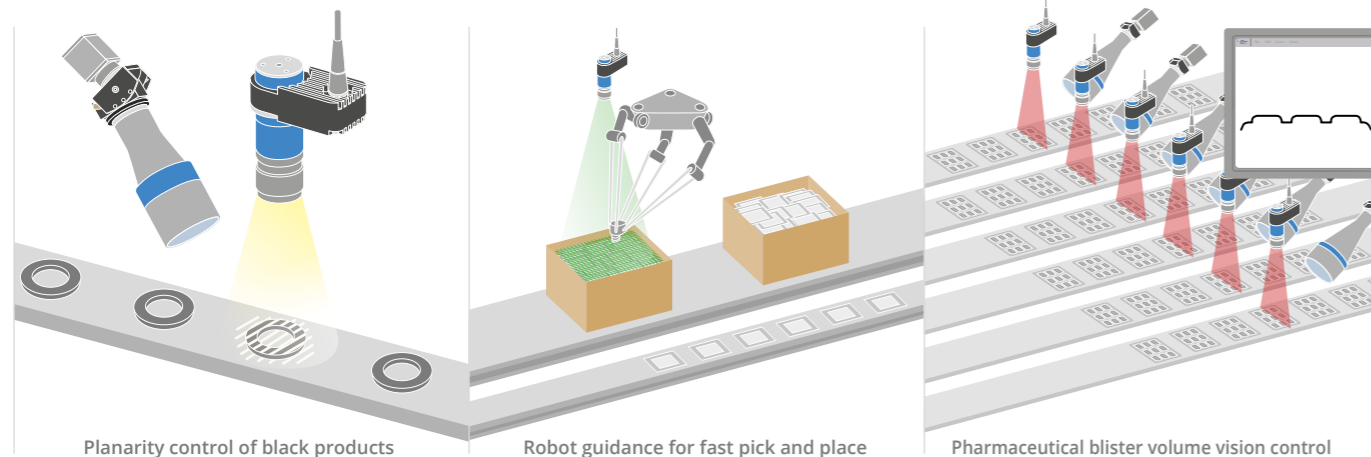

LTPRUP-x + CMHO016 clamping mechanics.



Three M4 and one M6 threads for additional fixing options.

FULL RANGE OF COMPATIBLE PROJECTION OPTICS		
	ENHR series	p. 92
FULL RANGE OF COMPATIBLE ACCESSORIES		
	Projection patterns PTPR series	p. 218
	Strobe controllers LTDV series	p. 222
	Clamping mechanics CMHO016	p. 200

Typical emission spectrum of white LEDs

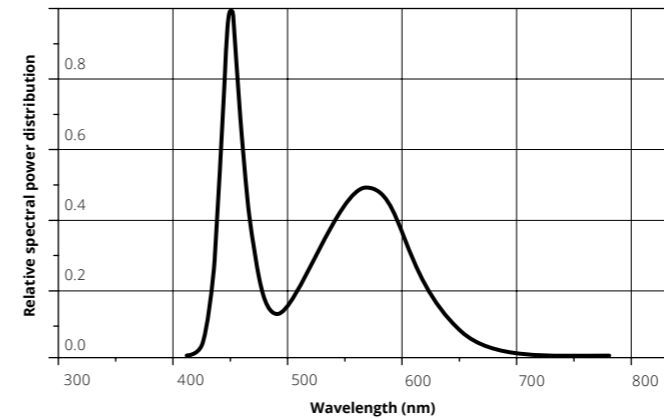

Typical emission spectrum of R,G,B LEDs

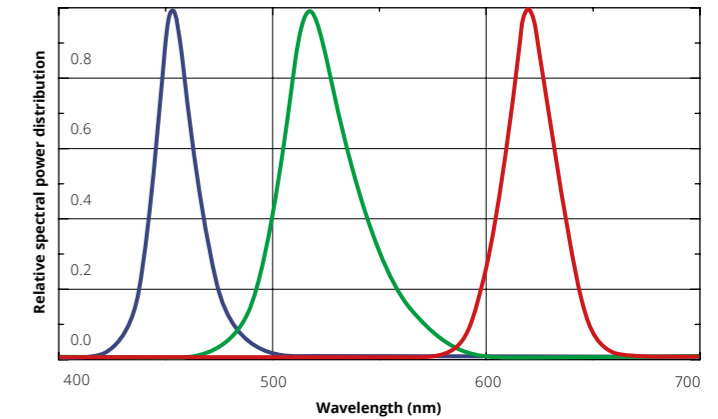

Part Number	LTPRUP-W	LTPRUP-R	LTPRUP-G	LTPRUP-B
Optical specifications				
Light color	White	Red, 618 nm	Green, 525 nm	Blue, 460 nm
Spectral FWHM (nm)	n.a.	20	40	30
Illuminance 1 (klux)	170	65	220	20
Electrical specifications				
Power supply mode		strobe only, constant current driving		
Driving current, max (A)	17	17	17	17
Pulse width 2 (ms)	<= 1	<= 1	<= 1	<= 1
Connection Type 3		M12 industrial male connector		
Estimated MTBF 4 (h)	> 50000	> 50000	> 50000	> 50000
Strobe peak LED source power (W)	90	90	90	90
Mechanical specifications				
Length 5 (mm)	108,9	108,9	108,9	108,9
Width (mm)	46	46	46	46
Height (mm)	93	93	93	93
Materials		anodized aluminum body		
Clamping system		3 Holes for M4 screw or 37.7 mm diameter clamp		
Compatibility				
Strobe controllers		LTDV1CH-17, LTDV1CH-17V, LTDV6CH		
Lenses		ENMP series, ENHR series, ENVF series, TC series, TCLWD series, TCHM series		
Cable		CBLT001, CBLT002		
Clamping mechanics		CMHO016		
Projection patterns		PTPR series		

1 With a 35 mm lens, F/N 1.4 at 100 mm working distance without projection pattern at driving current = 17A. Estimated value.

2 At 25°C. At max pulse width (1 ms), max pulse frequency = 15 Hz. Contact us to check other allowed combinations of duty cycle-frequency-temperature.

3 5 m cable with straight female connector included. Optional cable with right angled connector is also available and must be ordered separately (refer to our website for further info and ordering codes).

4 At 25° C.

5 Including connector.

LTPRUP series

Product insight

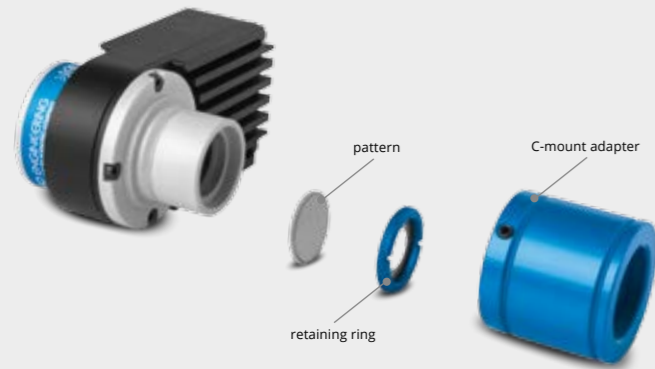

Custom-made pattern

Custom-made patterns can be supplied on request. A drawing with accurate geometrical information must be submitted (please refer to the instructions here below).

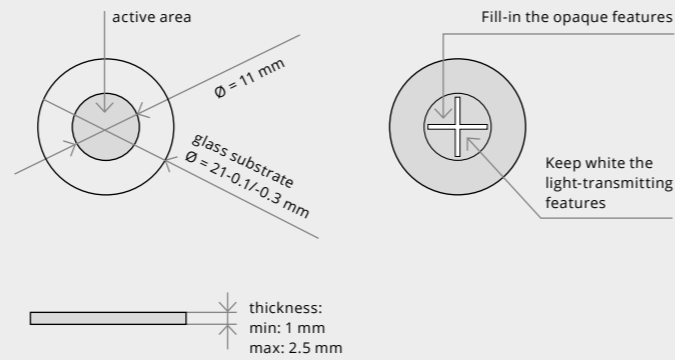

Pattern selection

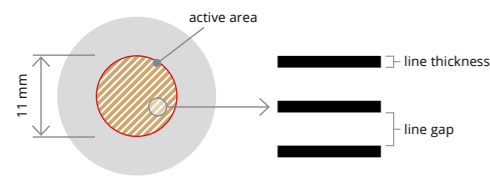

The projection pattern can be easily integrated into the LTPR projection unit by unscrewing the retaining ring that holds the pattern itself.

This simple procedure makes it easy to interchange different patterns on the same projection unit. The pattern outer diameter is 21 mm, while the active projection area is a circle of \varnothing 11 mm: all the significant features of the pattern are drawn inside this circle.

The projection area will have the same aspect ratio as the pattern. The projection accuracy depends both on the pattern manufacturing accuracy and lens distortion. The edge sharpness of the projected pattern depends on both the lens resolution and the engraving technique: laser-engraved patterns (part numbers ending in "L") or photolithography-engraved patterns (part numbers ending in "P") can be chosen depending on the type of application.

Photolithography patterns

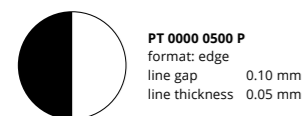

Laser engraved patterns

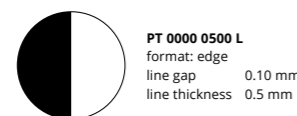
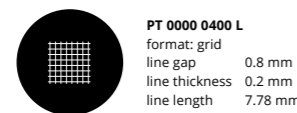
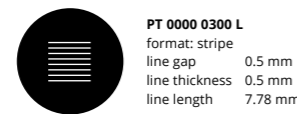
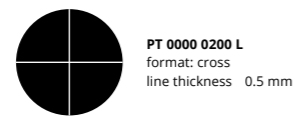

Pattern specifications

Photolithography patterns	
Substrate	Soda lime glass
Coating	Chrome
Geometrical accuracy	2 μ m
Edge sharpness	1.4 μ m
Laser engraved patterns	
Substrate	Borofloat glass
Coating	Dichroic mirror
Geometrical accuracy	50 μ m
Edge sharpness	50 μ m

Projection lens selection

The pattern drawing which has to be projected must be inscribed in a 11 mm diameter circle, same diagonal of a 2/3" detector. For example, the pattern drawing could cover the entire 11 mm diameter area or be like a 8.8 x 6.6 mm rectangle or, again, be a square whose side is 7.78 mm.

Unless the projection optics introduces significant distortion, the shape of the projected pattern will preserve the features and aspect ratio of the engraved pattern. The projected area dimensions will be "M" times the original dimensions of the pattern, where M is the optical magnification at which the selected projection lens is operating.

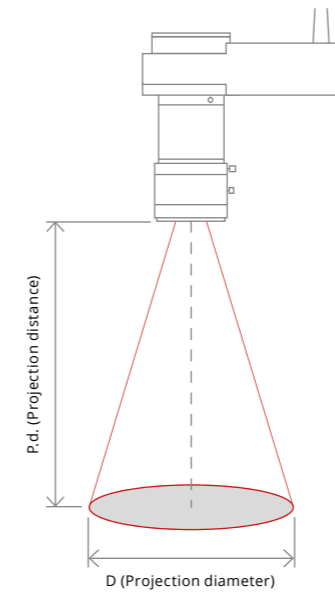

Pattern drawing and projection area

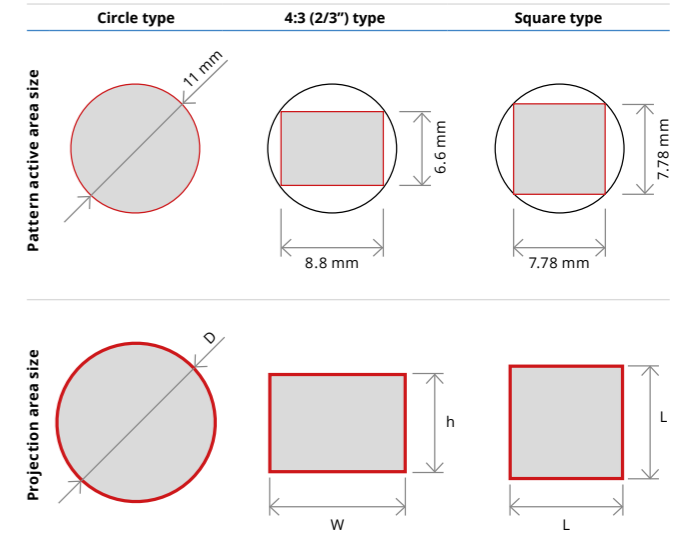

Telecentric lenses

	TC 23 004	TC 23 007	TC 23 009	TC 23 016	TC 23 024	TC 23 036
P.d. (mm)	57.1	61.2	63.3	45.3	69.2	103.5
D (mm)	5.5	8.3	11.0	20.8	31.4	45.2
	TC 23 048	TC 23 056	TC 23 064	TC 23 072	TC 23 080	TC 23 096
P.d. (mm)	134.6	159.3	182.3	227.7	227.7	279.6
D (mm)	59.8	70.0	80.0	89.9	99.7	117.8

2 / 3" C-mount lenses

P.d.	D (Projection diameter)								
	@50 mm	@75 mm	@100 mm	@150 mm	@200 mm	@250 mm	@300 mm	@400 mm	@500 mm
6 mm	81	127	172	264					
8 mm	58 (*)	92	127	195	264	333			
12 mm	35 (*)	58 (*)	81	127	172	218	264		
16 mm		41 (*)	58 (*)	92 (*)	127	161	195	264	333
25 mm				55 (*)	77 (*)	99 (*)	121 (*)	165	209 (*)
35 mm						68 (*)	83 (*)	115	146

(*) = spacers may be needed to compensate back focal length



LTPRUP+TC.



LTPRUP+C Mount Standard.